

# 多目的ホール・研修室・ご利用例

## 多目的ホール

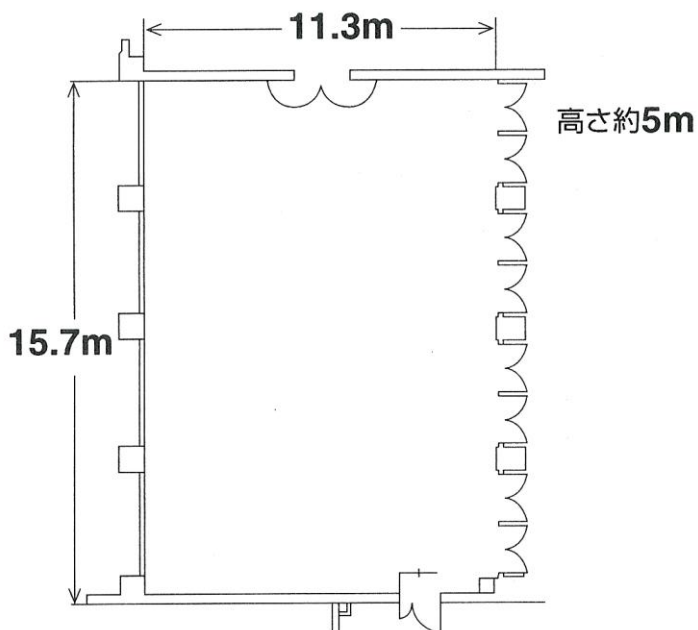

## 1階ロビーご利用例

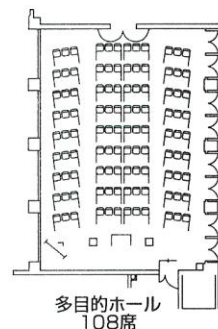
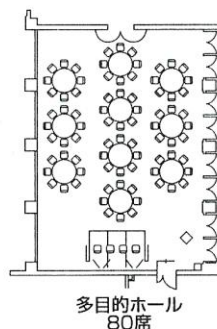
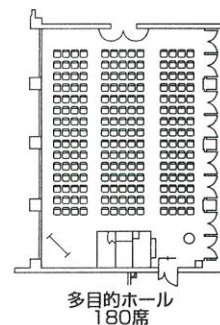

## 研修室A・B

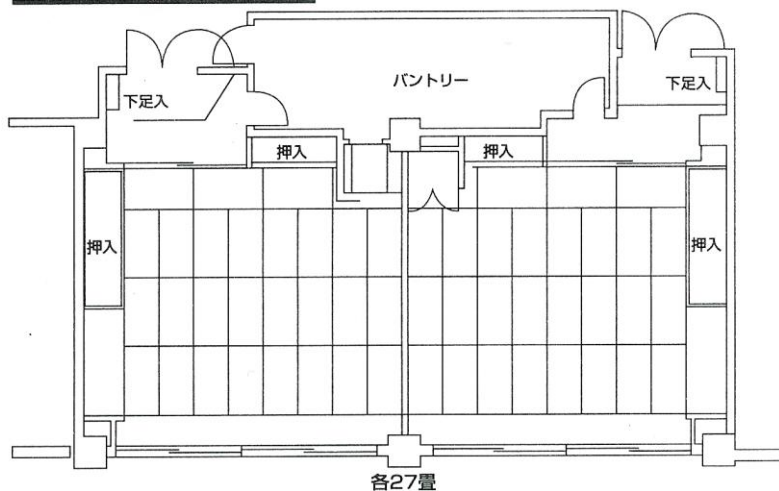

## 2階研修室ご利用例

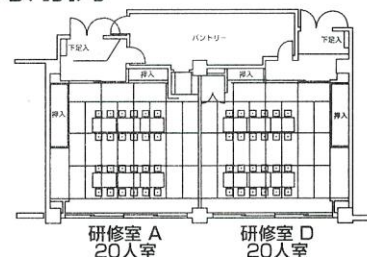

1室利用  
宴会 28席

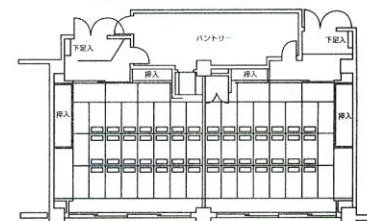

## 研修室C・D

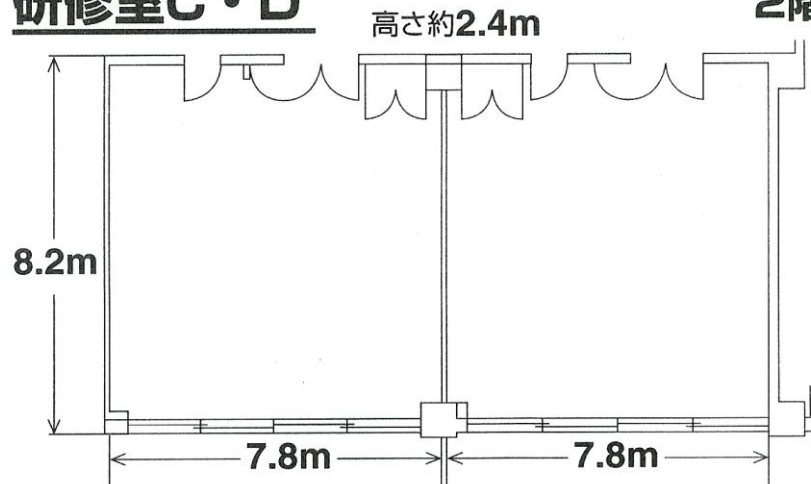

## 2階研修室ご利用例

●仕切をした場合

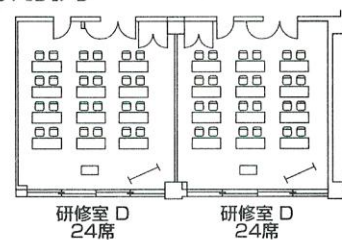

●仕切を外した場合

